



Brackets and Bolts/ Bespoke Designer

Email: sales@bracketsandbolts.com
Fax: 01 206 793200
Tel: 01 206 793100

Shoe Type 6

All Dimensions in Millimeters

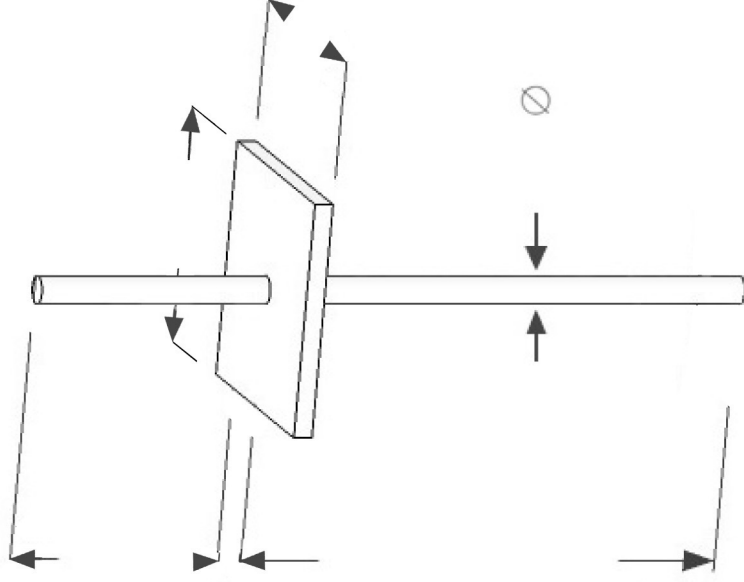

Bespoke Designer Request Form

Customer Information

Product: Shoe Type 6

Please add measurements to page 1

Name:

Company:

Site/ Ref:

Tel No:

Fax:

Email:

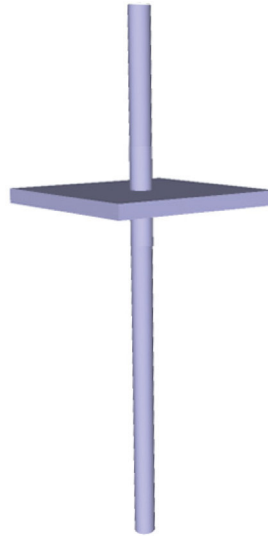

Order To Place: Tender:

Required By (Date):

Notes: Please add any other useful Information

Quantity:

Material Selection

Mild Steel: No Finish Primed Galvanised Powder Coated

Stainless Steel: (304) (316) Aluminium: